

Unisolierte Aderendhülse 25,00mm² - 12mm

Werkstoff: Cu-DHP, Oberfläche galvanisch verzinkt. Mindestschichtdicke 3µm.

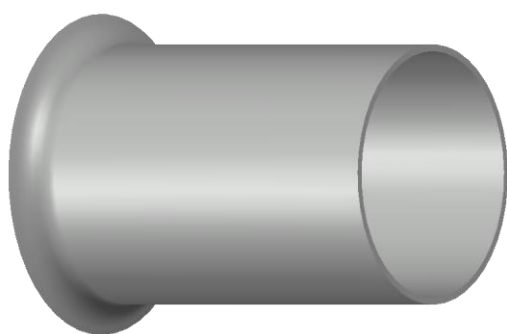

Technische Daten

Querschnitt (mm ²)	25,00
AWG	4
Gewicht (mg)	541



Abmessungen (mm):

d1	7,30
d2	9,50
l	12,00
s	0,20

